



Making our world more productive

OZORATM oxygen recovery system

Bringing ozone production to new efficiency levels

Abstract.

Linde's OZORA™ technology is an adsorption system that reduces the cost of ozone production by recycling the oxygen that typically passes unreacted through oxygen-fed ozone generators during the corona discharge process. In a partial pressure swing, ozone is adsorbed from the oxygen/ozone mixtures generated by an ozone generator, or generators, and desorbed to the treatment process under similar conditions using clean dry air (CDA) or nitrogen as the purge gas. OZORA can be used with any high-purity oxygen-fed ozone generator, targeting oxygen-related OPEX savings. Economic benefits may be obtained for ozone generation systems producing 30 kg/hr (1,500 ppd) or more of ozone. The OZORA system is targeted at water and wastewater treatment facilities for drinking water, wastewater or water reuse plants.

This case study covers the working principles of the technology, its integration with an ozone generator and a detailed overview of the system's demonstration results on a 1,000 ppd (~20 kg/hr) ozone generator at a drinking water treatment facility on the East Coast (USA). The demonstration, which was conducted in close collaboration with a leading ozone generator manufacturer, confirmed that the OZORA system recovered 60% or more of oxygen from ozone streams, while meeting the specifications for gas flow and composition, moisture, hydrocarbons and nitrogen.

Contents.

- 06 Introduction
- 07 OZORA operating principles
- 08 Integration with oxygen-fed ozone generators
- 09 Case study: Technology demonstration at a drinking water plant
 - System setup
 - Critical performance targets
 - Results
- 14 Conclusion

Introduction.

Water treatment operators are increasingly challenged to remove contaminants and micropollutants from water and to treat industrial wastewater with a high chemical oxygen demand (COD) as found in the textile, pharmaceutical and specialty chemicals industries.

Compared with conventional water and wastewater treatment processes, which fail to remove the contaminants completely, oxidation with ozone has proved to be one of the most efficient methods available. Most industrial-scale ozone generators are fed with oxygen (O₂) gas, since using pure oxygen offers clear advantages in terms of ozone production and footprint. However, during the corona discharge production process, only a small percentage of the gas is actually converted into ozone, with around 90% remaining unused.

But why would you waste oxygen when you can recover it?

Building on over thirty years of experience in the design and construction of adsorption plants, Linde developed OZORA, an oxygen recycling technology that captures unconverted oxygen before it escapes. OZORA takes the oxygen/ozone mix from the ozone generator and separates the oxygen from the ozone. The oxygen is fed back into the generator while the ozone is mixed with dry air before exiting the production process for its end purpose. As further discussed in the following case study, Linde's patented solution aims to reduce oxygen consumption by at least 60%, thus considerably reducing operating costs and bringing ozone production to new efficiency levels.

OZORA operating principles.

Fig.1 Representation of the OZORA technology



Based on the principles of Pressure Swing Adsorption (PSA), the OZORA technology uses adsorption to retain ozone while passing oxygen through for re-use during the adsorption stage. Then, retained ozone is desorbed using CDA and delivered as a product to the end-use point.

The system is comprised of an ozone adsorption unit placed downstream of an ozone generator and oxygen supply method. The ozone is separated (adsorbed) from O_2 in the OZORA unit and is then desorbed into the customer process using clean dry air (CDA) as a carrier.

Fig. 2 Adsorption step

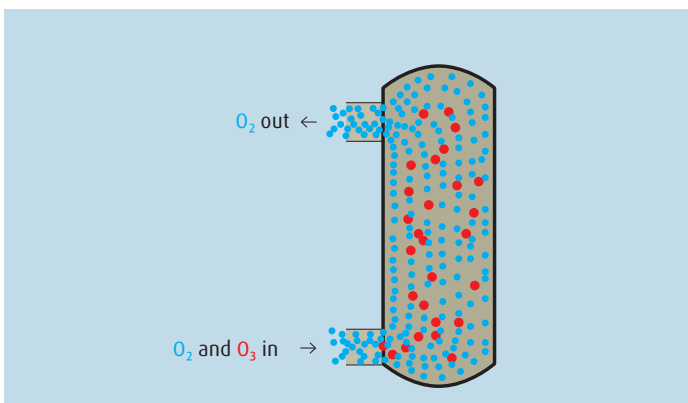

In the adsorption step, both oxygen and ozone enter the bed. Ozone is then selectively adsorbed by the sieve material, while oxygen passes through. Ozone remains captured in the bed while the oxygen is fed back to the ozone generator.

Fig. 3 Desorption step

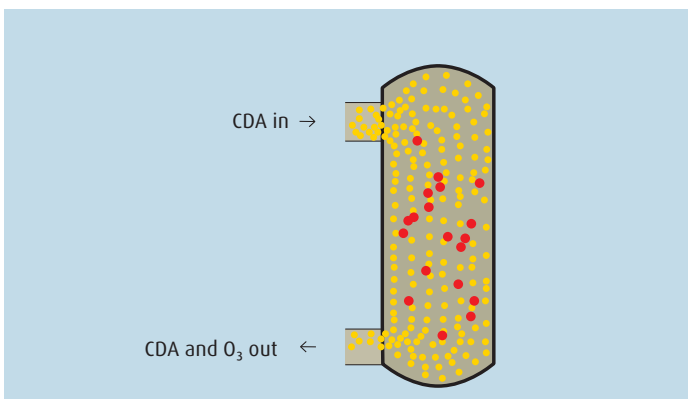

In the desorption step, CDA flows through the bed to release the ozone that has been captured in the previous step. An ozone/CDA mix leaves the bed at the same concentration as the incoming ozone so that it can be used for the plant's designated process.

Integration with oxygen-fed ozone generators.

The system has been engineered to provide seamless integration with the ozone generator(s) and is designed for compatibility with different ozone generator suppliers. The unit is connected to the existing oxygen feed, ozone generator(s) and end customer process through a piping system. Additionally, a CDA system – air compressor and dryer – and a vent ozone destruct unit (VOD) – which converts all venting ozone from the OZORA to oxygen – are required. The whole operation is controlled via a proprietary PLC program which starts and shuts down the system, automatically controls the cycles, monitors operation, sends alerts, and collects performance data.

As a reference, the overall footprint of the OZORA commercial version, to be used with a 60 kg/hr ozone generator, is:

OZORA skid: 8.3 m x 2.5 m (27.2 ft. x 8.2 ft.)

Blower: 1.7 m x 0.7 m (5.6 ft. x 2.3 ft.)

Dryer: 0.97 m x 1.4 m (3.2 ft. x 4.6 ft.)

Fig. 4 OZORA integration with the ozone generator

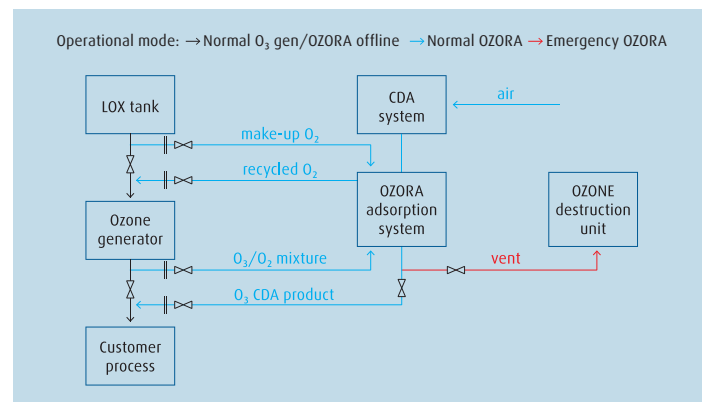

Case study: Technology demonstration at a drinking water plant.

Fig.5 Diagram of the OZORA system set-up

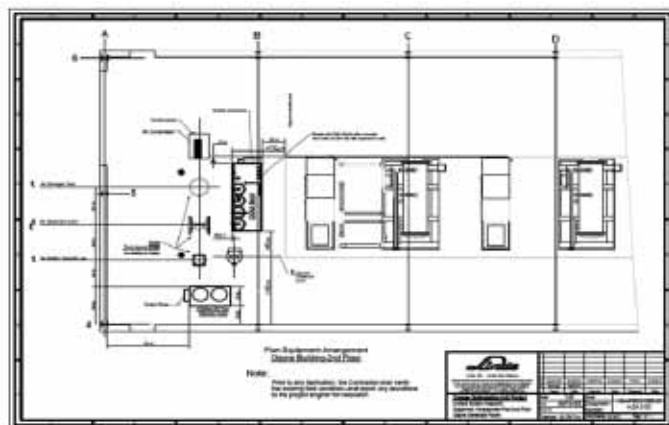

The OZORA demo system was installed and tested at a drinking water plant on the East Coast (USA). The results presented in this paper refer to data collected in two phases, running respectively for 1,148 continuous hours and an additional 500 continuous hours. In the first phase, the Linde expert team collected performance data which they used to further improve the performance of the system, mainly in terms of stability and the oxygen recovery rate (ORR). The upgrades were tested in the second phase for an additional 500 hours and are featured in all commercial-scale units.

Ozora System set-up at the DWT Plant

For the demonstration of the OZORA technology, a pilot-scale system was connected to one of three ozone generators. Each ozone generator had a production capacity of 1,000 ppd (~20 kg/hr) for a total production capacity of 3,000 ppd (~60 kg/hr).

The installation also included a CDA system comprising an air compressor and a dryer. A catalytic VOD system was included to convert all venting ozone from the OZORA system to oxygen. Cooling water for the VOD, the blower and the outlet oxygen from the blower was provided by a packaged chiller.

The oxygen feed to the ozone generator and the ozone outlet from the ozone generator included block valves to direct flow to the OZORA system or to enable the ozone generators to operate independently from the OZORA system.

Critical Performance Targets

To test the performance of the technology, a set of critical performance targets was established (Table 1) and closely monitored throughout the trial.

Table 1 Critical Performance Targets

Metric	Target	Actual (Average)
Oxygen Recovery Rate ¹	≥60%	62.8%
Ozone Product Flow _{in} vs Flow _{out}	±2%	+2.4%
% Ozone _{in} vs % Ozone _{out} ²	±0.2%	-0.18 wt%
Net Savings ³ (% Current Oxygen Spend)	≥20%	21%
Ozone Product _{out} vs Product _{in} ⁴	≥98%	100.15%
Oxygen Supply Pressure ⁵ (instantaneous)	±0.25 psig	2.19 psig
Recovered Oxygen Purity	≥98%	97.3%

¹ Average over two full OZORA cycles (approx. 7 mins). Adsorbed O₃ in beds leads to approx. two-cycle lag in response to flow/concentration changes

² Ozone concentration deviation due to ozone meter miscalibration. Typically, Ozone_{in} and Ozone_{out} concentrations +/- 0.05 wt%

³ For 60 kg/hr commercial OZORA unit with performance of demo unit (economics do not scale down well to demo unit size)

⁴ Calculated value over time. Product in & out calculated (flow X wt%). Out of phase based on adsorb/desorb cycles

⁵ Blower boosted pressure ~ 2 psi resulting in supply pressure too high. Modification of oxygen feed to resolve the issue in future

Results

In this section, we will delve into more detail on the key learnings and collected data for the critical performance targets 1 to 4, as defined for the demonstration (Table 1). The remaining critical targets were also carefully monitored and analyzed – purity of the recovered oxygen, ozone product in vs out, operational reliability and supply pressure. All were exceeded except the pressure. Over the course of the demonstration, the pressure to the ozone generators was higher than the specified 17.5 to 18 psig. This was a consequence of the partial implementation (on one ozone generator) and the temporary nature of the demonstration and will not be an issue for commercial installations.

Critical Target 1: Oxygen recovery rate (ORR)

Oxygen recovery is the most compelling factor leading to the installation of the OZORA oxygen recovery system. For the demonstration, a flow meter was installed in the makeup oxygen piping. Since the makeup oxygen automatically feeds the balance of oxygen necessary to provide all of the required flow to the ozone generator, the recycled oxygen can be calculated by subtracting the makeup oxygen flow rate from the total flow rate through the ozone generator. The flow meter in the makeup oxygen line provided a very accurate measure of the ORR, which is the recovered oxygen flow rate divided by the total oxygen flow rate.

The actual instantaneous ORR fluctuates considerably depending on the active step in the cycles. It can vary from less than 20% when oxygen purge is required to more than 80% when two beds are recovering oxygen. To provide a meaningful representation of the ORR, the running average ORR over two cycles is used in the reported results.

Since the demonstration took place at a working facility, the focus in the early stages was on ozone concentration and oxygen purity, this being the reason why we observe a lower ORR at the earlier stages of Phase I in the charts. As these critical factors were stabilized, focus shifted to the ORR and a steady improvement can be observed as a result. After operating for 50 continuous days – Phase I – the team observed that pressure control is an essential factor affecting ORR. It was then determined that a pressure control modification was necessary in order to stabilize cycles and improve the ORR, from 57.7 to 62.2%.

The above-mentioned controls are included in the commercial unit design – the ORR can therefore be expected to be consistently above 60% for all future commercial OZORA systems.

Fig. 6 OZORA oxygen recovery rate for test phases I and II

Phase1: ORR two-cycle average

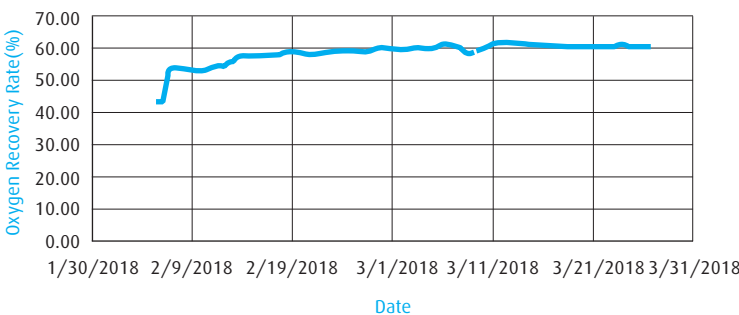

Phase2: ORR two-cycle average

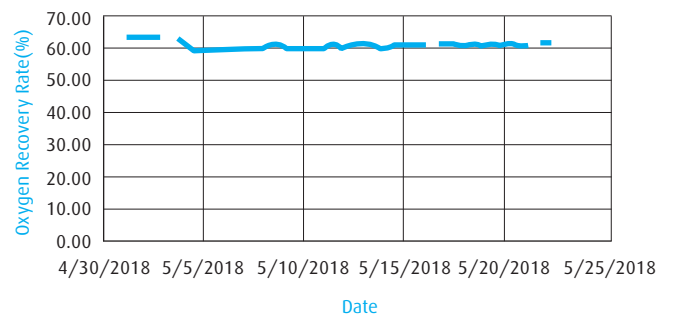

Critical Target 2: Ozone product flow

A key objective of the OZORA system development was to achieve a stable ozone product output matching the input throughout the cycles.

The OZORA system is not a flow-through technology as there is a lag in time between adsorption (from the ozone generator) and desorption (to the contactors). There are two distinct gas streams from the OZORA system: oxygen (recycled and makeup) to the ozone generator, and ozone product (CDA and ozone) to the contactors.

The patented four-bed design overlaps desorption cycles, levelling peaks and valleys in the ozone concentration. In addition, the patent-pending flow control algorithm was designed to stabilize ozone product flow patterns during the desorption cycles, even with the significant flow perturbations resulting from cycle transitions. The testing protocol set high requirements for consistent ozone product flow and concentration.

The acceptance criteria for the flow rate was set at $\pm 2\%$ of the “expected ozone product flow rate”; a value derived from the total flow rate to the contactors divided by the number of active ozone generators.

The result over the course of Phase I was +7.2% – higher than the acceptance criteria. In early testing, the outlet temperature from the in-line ozone destruct vessel was high – an indication of ozone breakthrough. To combat the risk and increase the system’s capacity, the desorption CDA flow rate was set approximately 3 to 6% higher as a precaution to ensure the beds were fully desorbed and to push the breakthrough front to a lower position in the beds.

This did increase the total product outlet flow rate somewhat, but it was only excess CDA that was affected. The concentration of ozone product to the contactors remained the same, as did the amount of ozone sent to the basins.

In subsequent tests, the amount of excess CDA was reduced and the flow deviation improved as a result. For Phase II, the flow deviation was 2.4%. This value will be reduced further to a maximum of 2% for commercial systems

Fig. 7 OZORA flow rate for test phase I

Phase1: O₃ Flow_{in} vs O₃ Flow_{out}

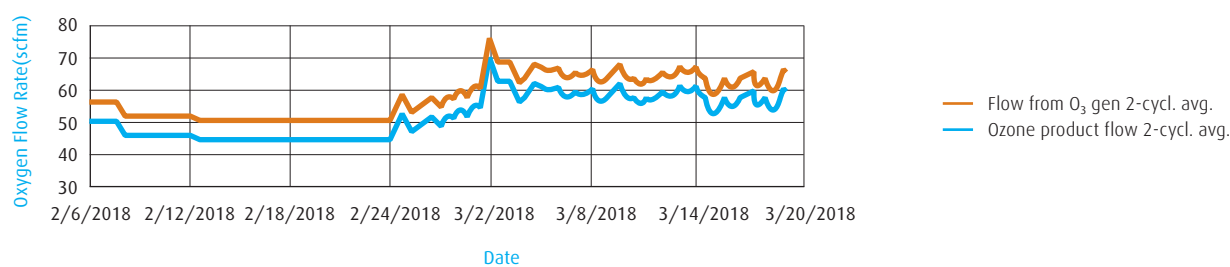
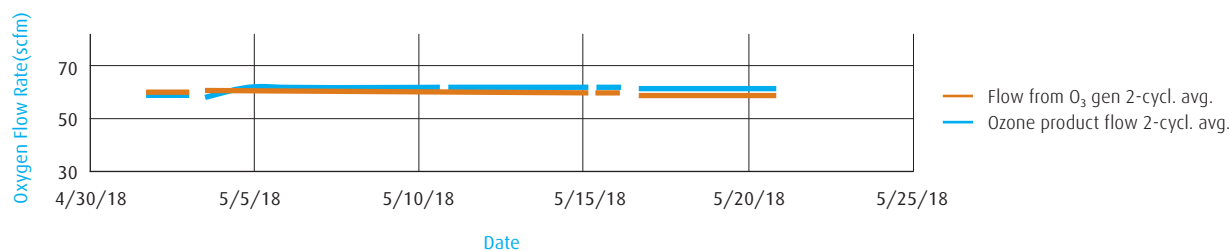

Fig. 8 OZORA flow rate for test phases I and II

Phase2: O₃ Flow_{in} vs O₃ Flow_{out}



Critical Target 3: Ozone concentration

It is the nature of adsorption systems to have some variability in product concentration as the desorption step progresses. The concentration generally gets lower during the last seconds of desorption. The OZORA cycles have two overlapping desorption steps – the first half of desorption and the second. At all times in the OZORA cycles, one bed is in the first half of desorption and the other is in the second half. This has been shown to provide very consistent ozone product concentration without the need for a buffer tank.

The specification for deviation of ozone concentration was $\pm 0.2\%$. The value is the running average calculated over two OZORA cycles. For Phase I, the running average was -0.04% . For Phase II, the average was 0.18% . Trending data shows that the instantaneous concentration did vary by up to 1% . However, the measurement point was right at the outlet of the beds and mixing in the downstream piping had the effect of levelling the concentration at the contactors. The basins' off-gas ozone concentration was very stable – an indication that the ozone concentration to the contactors was also very stable.

Fig. 9 OZORA ozone concentration for test phase I

Phase1: OZORA O₃ Conc'n_{out} vs O₃ Conc'n_{in}

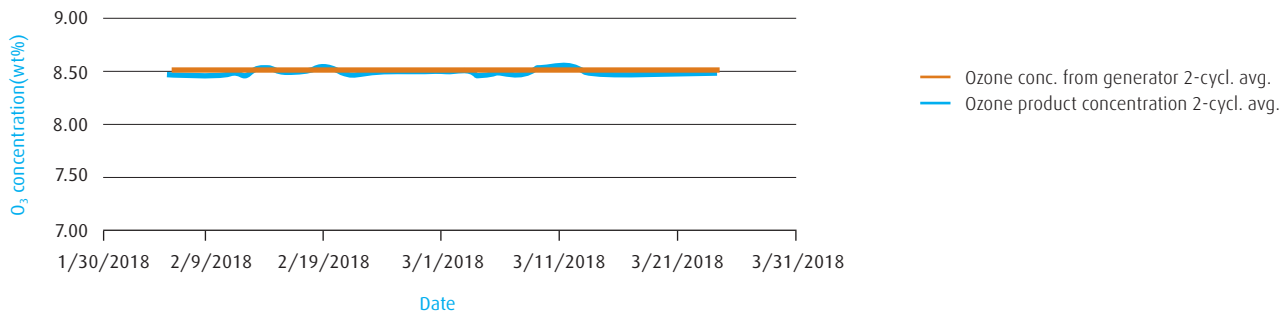
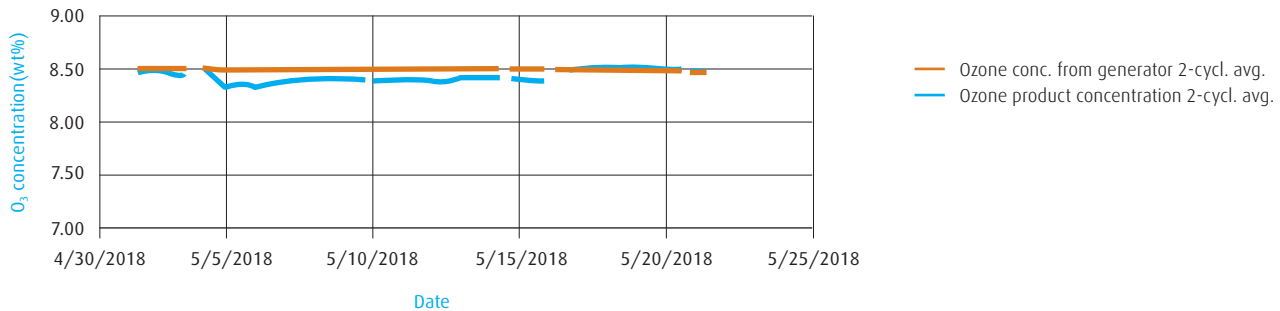

Fig. 10 OZORA ozone concentration for test phase II

Phase2: OZORA O₃ Conc'n_{out} vs O₃ Conc'n_{in}



* Ozone concentration difference in Phase II is due to miscalibration of ozone analyzer.

Critical Target 4: Net savings

Economic benefits of OZORA:

- Oxygen savings: The fundamental driver for the OZORA technology is the reduction in cost of ozone production. The biggest share of savings comes from the recovery and recycling of oxygen from the ozone stream. With an ORR of 60% or more, oxygen savings alone can justify the installation of the technology.
- Positive impact on generator maintenance and performance: During the trials, it has been observed that the quality of the recycled oxygen generally exceeds that of the oxygen supply. FTIR (Fourier Transform Infrared) analysis of the gas streams has found that the hydrocarbon concentration is generally significantly lower in the recycled oxygen stream. As a result, the OZORA system offers the added benefit of reducing maintenance (cleaning) costs resulting from accumulation of contaminants in the ozone generators, as well as providing better operational efficiency over a longer period.
- Offset nitrogen dosing system costs: OZORA can also offset the costs associated with nitrogen dosing systems. Since the purity of the recycled oxygen stream can be controlled by the OZORA system's cycles, nitrogen concentration can be regulated within the system.

Net savings calculation

Modelling of OZORA net savings has shown that results are sensitive to four significant factors:

- Ozone throughput (kg/hr or lbs/day)
- Oxygen price
- Power cost
- Ozone concentration

The OZORA equipment cost does not scale down. Therefore the OZORA technology is likely to be more economical when the ozone production rate is greater than 1,500 lbs/day (30 kg/hr). The scale used for the demonstration (15 kg/hr of actual production capacity) is not representative of commercial systems' economics. For the purpose of the net savings calculation, the results were scaled up to a commercial system (32 kg/hr of actual production) and only the oxygen savings were considered, since the full impact of the other benefits has not been fully quantified yet. For the evaluation, the prevailing market pricing for oxygen and electrical power in the USA was used and the ozone concentration was set at 8.5%¹. The calculation below assumes a 15-year equipment lease², with scheduled maintenance included in the monthly fee³.

Table 2 Net savings calculation with OZORA (estimate)

	Without OZORA	With OZORA
Oxygen cost (annual,USD)	\$304,920	\$116,664
OZORA lease		\$74,613
Power costs		\$48,881
Total	\$304,920	\$240,158
Net savings		21%

¹ Cases must be evaluated separately as geographical variations exist for power and oxygen costs

² The lease model might differ from country to country. Please contact a local Linde representative for details or send an email to ozora@linde.com

³ Maintenance includes blower servicing, instrument calibration, valve servicing and replacement of the adsorbent if necessary

Conclusion.

As described in the case study, the demonstration at the drinking water plant showed the OZORA system to be effective in recovering at least 60% of oxygen from an ozone stream at a working water treatment facility, meeting or exceeding critical targets such as oxygen recovery rate (ORR) and ozone concentration, while providing net annual savings of just over 20%.

Similar economic benefits can be obtained with ozone production rates of 30 kg/hr (1,500 ppd) or more of ozone.

Based on the demonstration, Linde made improvements to the OZORA system, which are expected to deliver the following benefits:

- Savings of 20%+ in total ozone system operational costs
- Seamless installation and integration with new or existing ozone generators
- No change in outlet flow
- Maintain purity of O₂ recycled back to the ozone generator
- Maintain the same ozone concentration as the ozone generator
- Reliable operation
- Easily bypassed if needed, without interrupting ozone production
- Available in standard and custom sizes

Getting ahead through innovation.

With its innovative concepts, Linde is playing a pioneering role in the global market. As a technology leader, it is our task to constantly raise the bar. Traditionally driven by entrepreneurship, we are working steadily on new high-quality products and innovative processes.

Linde offers more. We create added value, clearly discernible competitive advantages, and greater profitability. Each concept is tailored specifically to meet our customers' requirements – offering standardised as well as customised solutions. This applies to all industries and all companies regardless of their size.

If you want to keep pace with tomorrow's competition, you need a partner by your side for whom top quality, process optimisation, and enhanced productivity are part of daily business. However, we define partnership not merely as being there for you but being with you. After all, joint activities form the core of commercial success.

Linde – Making our world more productive.

www.linde-gas.dk, www.linde-gas.ee, www.linde-gas.fi, www.linde-gas.is, www.linde-gas.lt, www.linde-gas.lv,
www.linde-gas.no, www.linde-gas.se

Linde is a trading name used by companies within Linde plc. The Linde logo and the Linde word are trademarks of Linde plc. SOLVOX® is an EU-registered trademark of Linde plc. Trademark registrations and their status may differ from one location to another. Copyright © 2019. Linde plc.